

Article number: 203180M20125B1V

Description: E+G levelling foot
GN 31-80-M20-125-B1-V

Note: V Without nut, External hexagon at the top, Wrench flat at the bottom

Measures

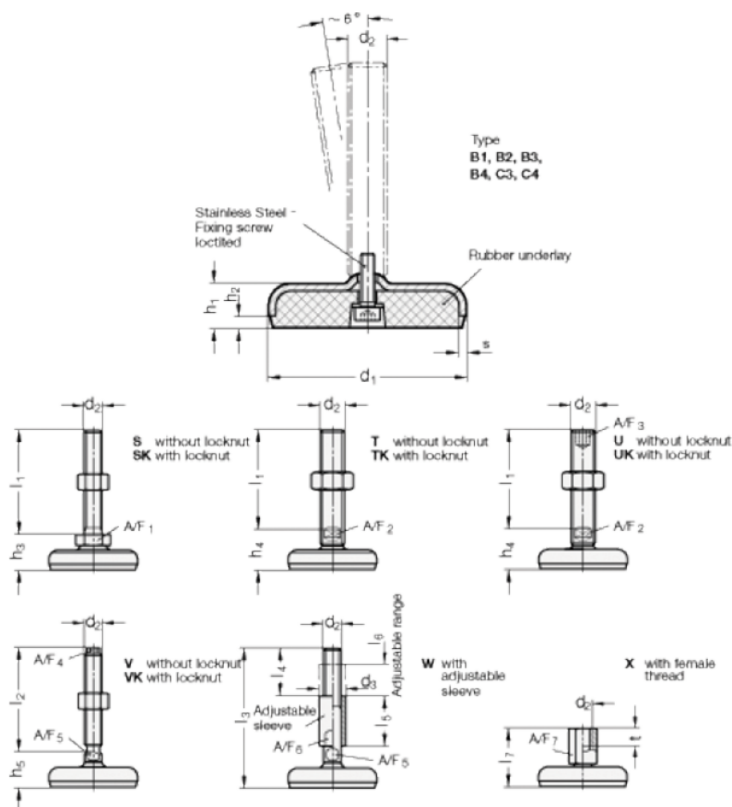

A/F4 = 13

s = 3

A/F5 = 16

d1 = 80

d2 = 20

h1 = 18

h2 = 5

h5 +4.0/0 = 30

l2 = 125